

CRL PA100 and PA110 Series Panic Handles

- **UL, ULC, and ANSI/BHMA Certified**
- **For 1/2" or 3/4" (12 or 19 mm) Tempered Glass Doors**
- **Wide Selection of Exterior Fixed Handles**



- **Available in Polished and Brushed Stainless, Satin and Polished Brass, and Oil Rubbed Bronze**
- **Custom Finishes Available By Special Order**
- **Custom Sizes Ship Within One to Two Weeks**

CRL manufactures a complete line of Panic Handles designed with the 'all-glass' door in mind. These elegant tubular devices give you maximum viewing area and a contemporary look when used on 1/2" or 3/4" (12 or 19 mm) tempered glass doors.

The most popular of these Panics is our PA100 Series. They provide a solution to the strict Americans With Disabilities Act (A.D.A.) Codes that confront every manufacturer and installer of 'all-glass' doors.

The interior portion of the device is a slender 1-1/4" (32 mm) tube stretching across the door and then gently turning upwards to the top of the door, eliminating any interference at the lower half of the door, which must remain clear of obstructions to pass A.D.A. demands.

The operating mechanism is completely concealed within the tube, and retracts a roller latch bolt at the top of the door when pushed gently. Complementing the sleek interior look, we offer a large selection of exterior pull handles that can be as simple as a horizontal handle (Model PA100A) to one that mirrors the interior device (Model PA100D).

All PA100 Series Panic Handles come with a 'dogging' feature that allows you to lock the device in the open position by simply sliding a lever, giving free access during business hours. They also can be used in conjunction with an Electric Strike, allowing for remote keyless entry. For your convenience, Custom Headers are available with all strike hardware installed.

When A.D.A. Codes are not a concern, we also offer our PA110 Series Panic Handles. These Panics are of the same sleek design as the PA100 Series, except they stretch across the door and then bend downward to the bottom of the door, latching at the floor or threshold.

They operate just like the PA100 Series Panics, and have the same 'dogging' feature. Strikes are available for either threshold or no threshold applications providing secure, accurate latching every time.

All of our PA100 and PA110 Panic Handles go through rigorous testing before they leave our manufacturing facility, ensuring that a high quality, dependable Panic will serve your customer for years to come.

Most importantly, they are all UL305, ULC/5132-93, and ANSI/BHMA A156.3-2001, Grade 1 Certified. No other Panic of this type can make this claim, and that puts CRL Panic Handles a step ahead of all the rest.

For more information on our PA100 and PA110 Series Panic Handles, see pages H198 to H204, or visit our web site at crlaurence.com.



- **Models for Aluminum or Wood Doors Available on Special Order**



Contact CRL Technical Sales at (800) 421-6144 in the U.S., (877) 421-6144 from Canada, or (323) 588-1281 International, and ask for Ext. 7700. You can also send e-mail from the crlaurence.com home page. Click on Contact Us, and then click on Technical Sales.

NOTE: All Access Control Handles on this page function as health and safety tools, and may only be purchased through CRL Authorized Glass Temperers and Door Manufacturers.

LOG ON TO crlaurence.com FOR BUSINESS-TO-BUSINESS SERVICES

PHONE (800) 421-6144 | FAX (800) 262-3299 TOLL FREE FROM ANYWHERE IN THE U.S.A. OR CANADA | H197



Standard Interior Configurations for CRL Panic Handles

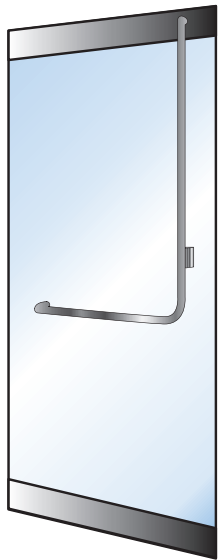

PA100 Series

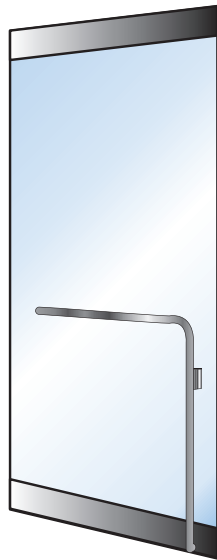

PA110 Series

Available with or without Keyed Access Device



Exterior Handle Combinations for Doors with CRL Panic Handles



Models with Exterior Handles A or D can be seen on page H200

NOTE: All Exterior Fixed Handles below can be used in combination with any Panic Handle.

Contact CRL Technical Sales at (800) 421-6144 in the U.S., (877) 421-6144 from Canada, or (323) 588-1281 International. Ask for Ext. 7700. You can also send e-mail from the crlaurence.com home page. Click on Contact Us, and then click on Technical Sales.

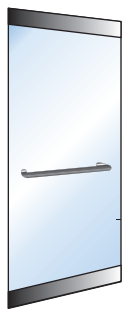

Handle A



Handle D

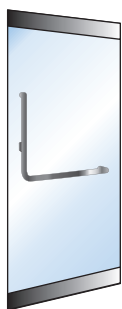

Handle B



Handle C



Handle E

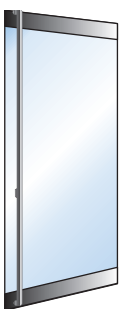

Handle F

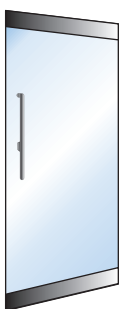

Handle G



Handle H

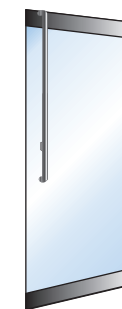

Handle J

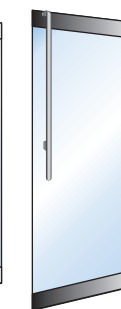

Handle J-S

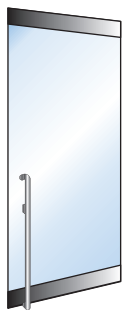

Handle K

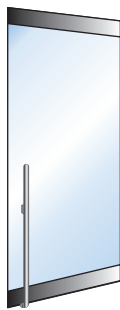

Handle K-S

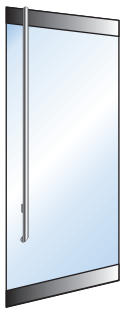

Handle L

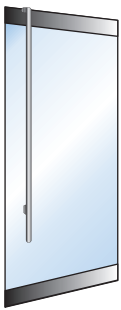

Handle L-S

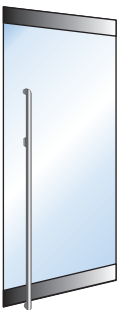

Handle M

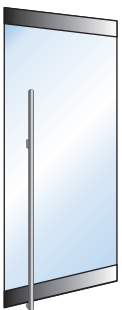

Handle M-S

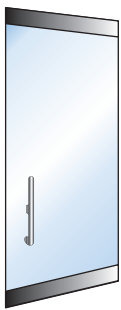

Handle N

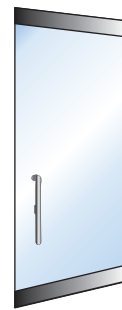

Handle P

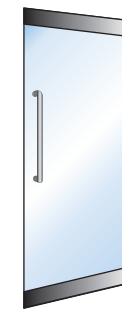

Handle X



Handle Y

NOTE: All Access Control Handles on this page function as health and safety tools, and may only be purchased through CRL Authorized Glass Temperers and Door Manufacturers.

CRL Panic Handle Size Limitations

Increased Sizes Make Door Assemblies Heavier and More Flexible. Therefore, the Following Should Be Considered:

- Wind Load, Stack Pressure, and Ventilation Loads
- Mounting Conditions of Doors to Building Structure
- Panic Devices, Deadbolt Locks, or Other Hardware
- Overhead or Floor Closer Characteristics
- Heavy Usage and Frequency of Operation
- Comfortable Feel and Ease of Door Operation



The Architect's Structural Engineer Should Be Consulted So That the Door Design is Correct for the Intended Use.

CRL PA100 Series Panic Handles

• Top Latching

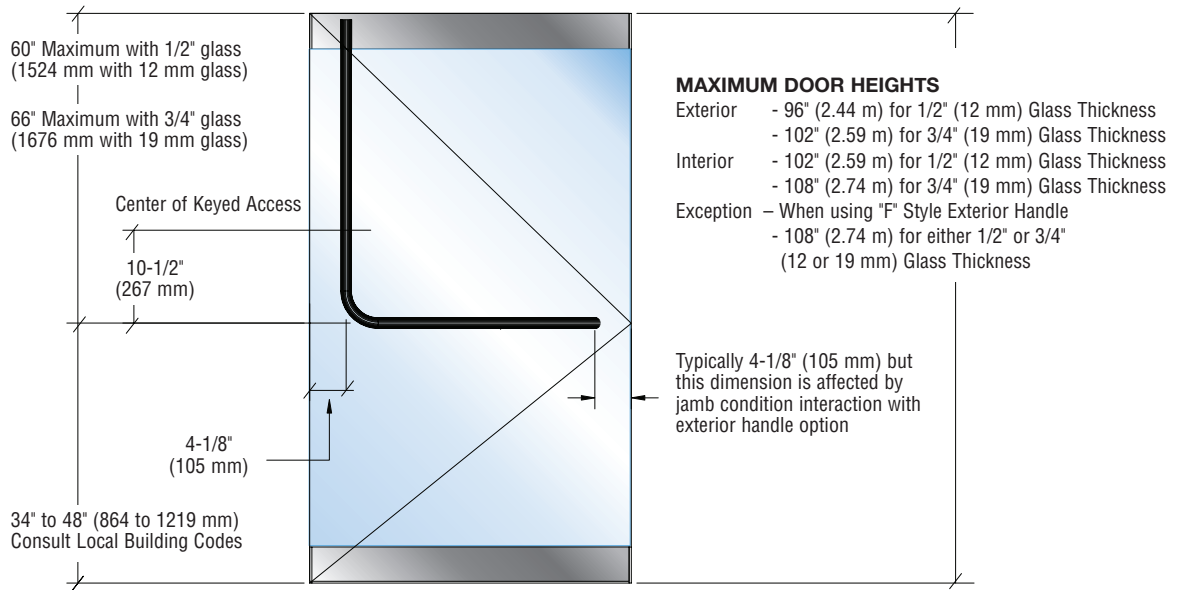

CRL PA110 Series Panic Handles

• Bottom Latching

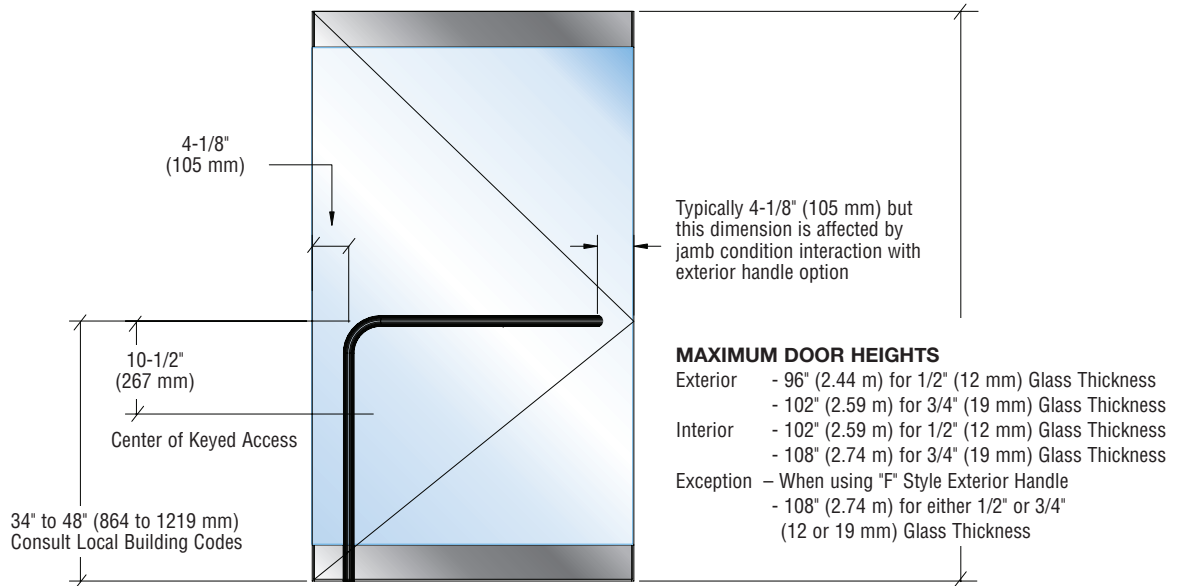

Contact CRL Technical Sales at (800) 421-6144 in the U.S., (877) 421-6144 from Canada, or (323) 588-1281 International, and ask for Ext. 7700.

You can also send e-mail from the crlaurence.com home page. Click on Contact Us, and then click on Technical Sales.

NOTE: All Access Control Handles on this page function as health and safety tools, and may only be purchased through CRL Authorized Glass Temperers and Door Manufacturers.



LOG ON TO crlaurence.com FOR BUSINESS-TO-BUSINESS SERVICES

H198 | PHONE (800) 421-6144 | FAX (800) 262-3299 TOLL FREE FROM ANYWHERE IN THE U.S.A. OR CANADA